



1/18 (row1 col1)







4/18 (row1 col4)

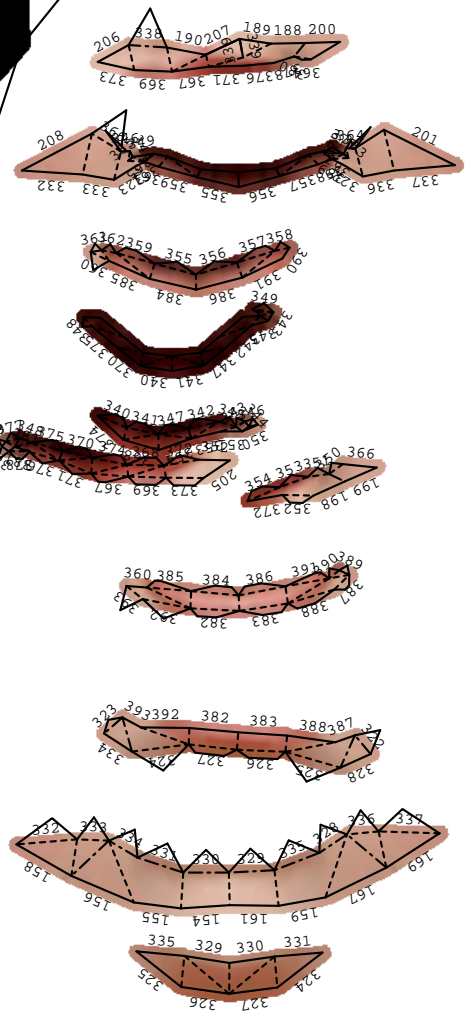
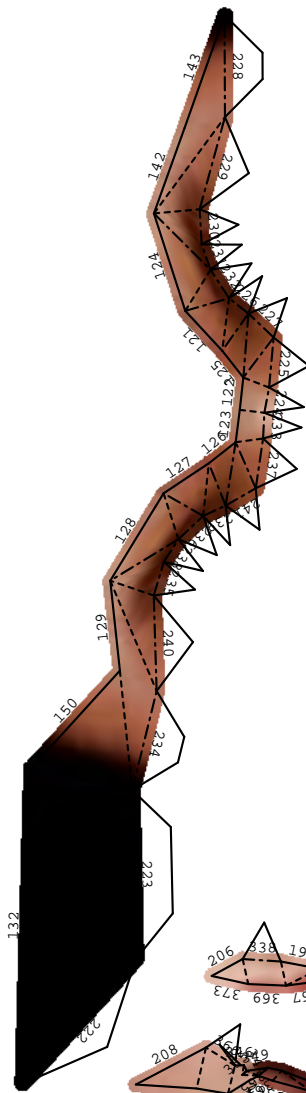
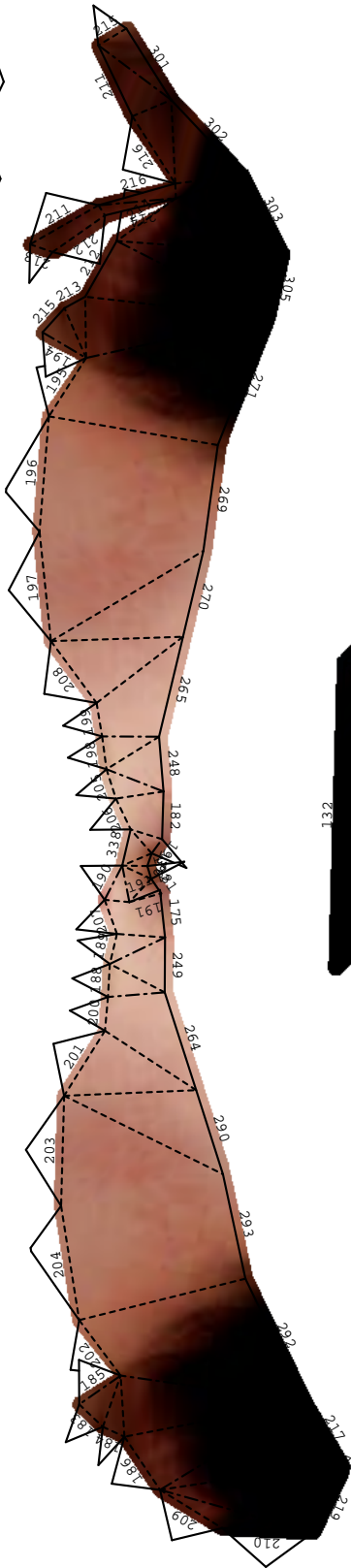
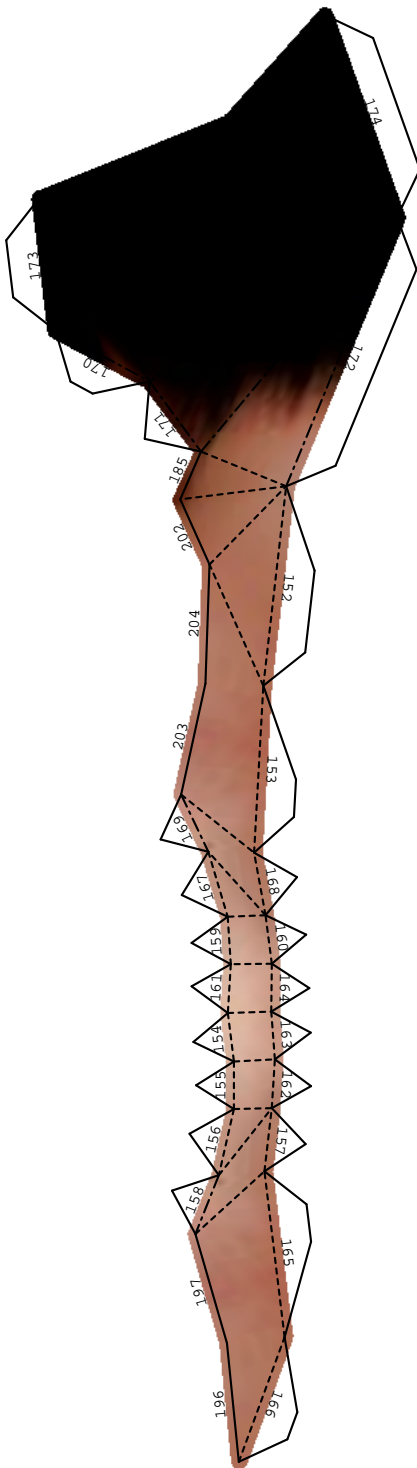





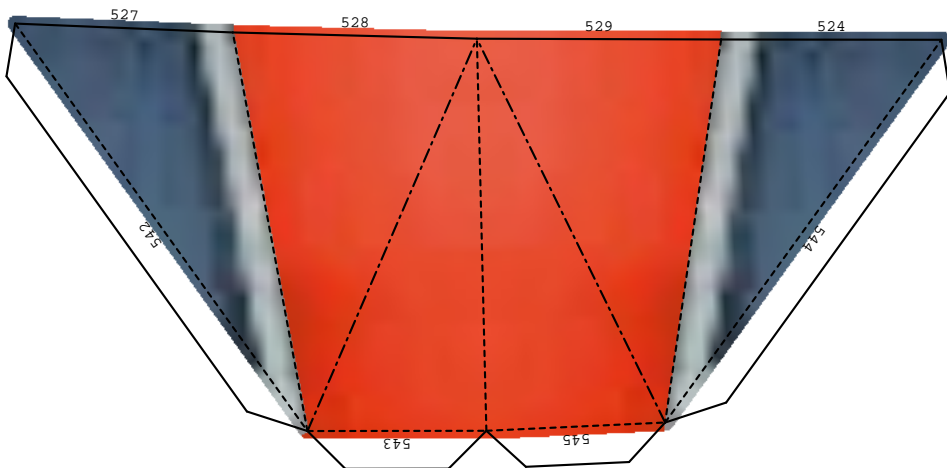
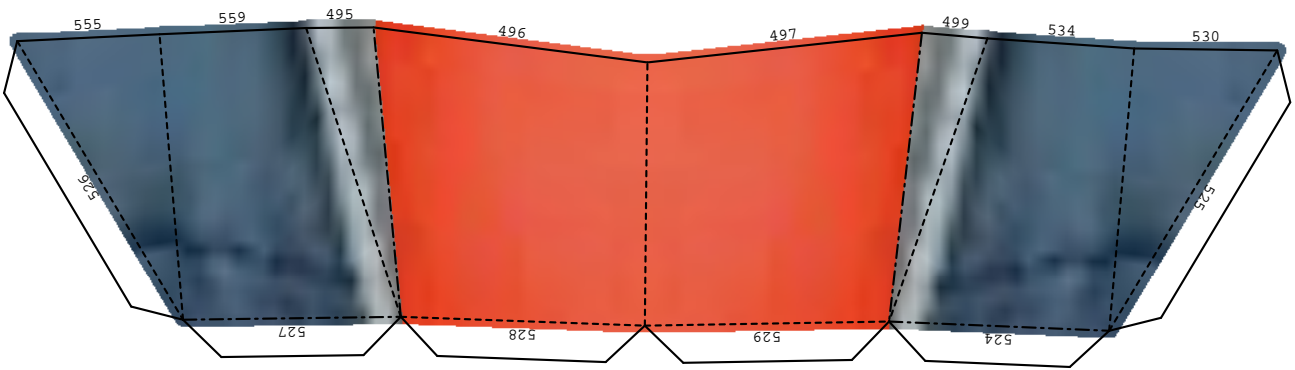
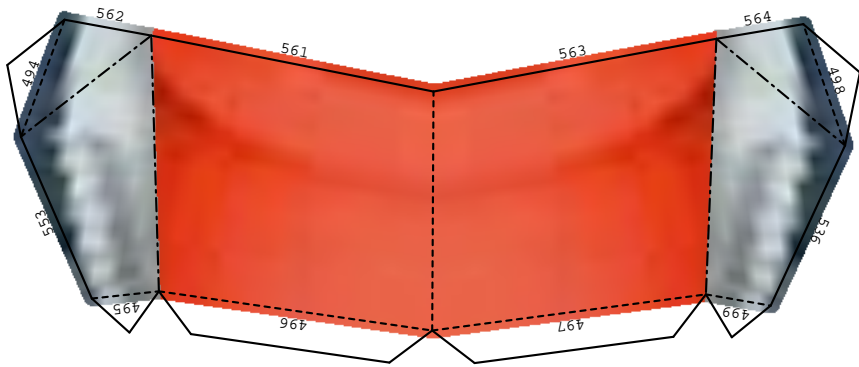
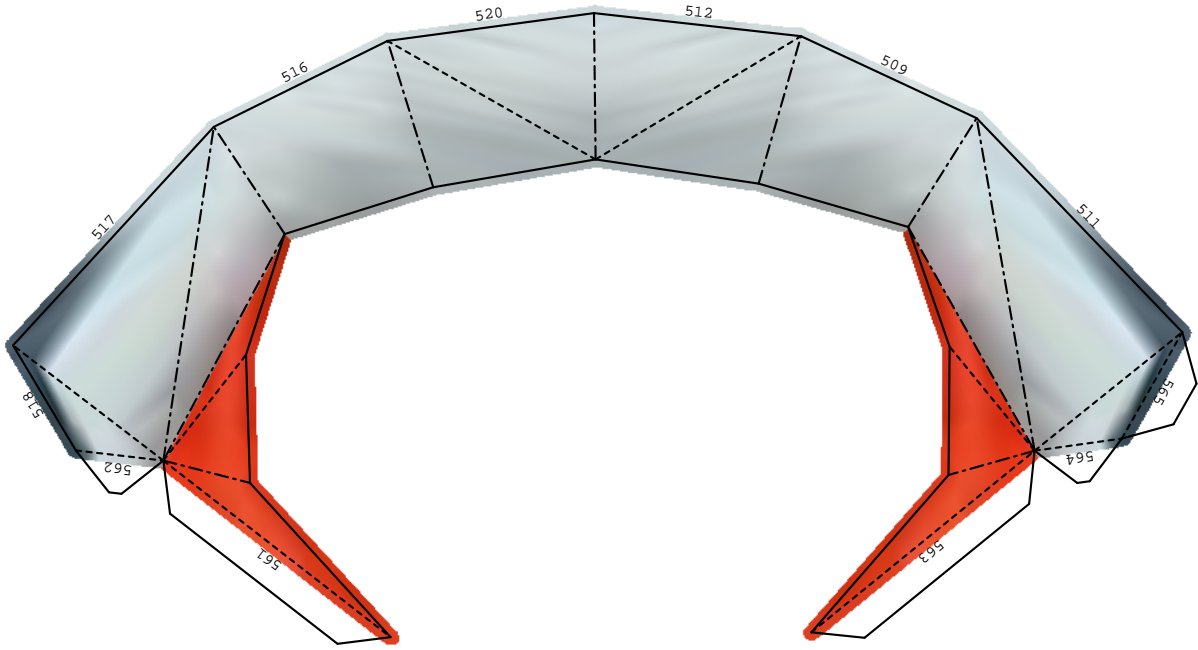

7/18 (row2 col1)

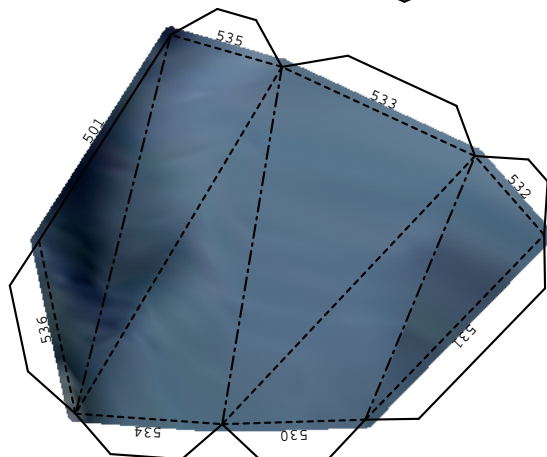
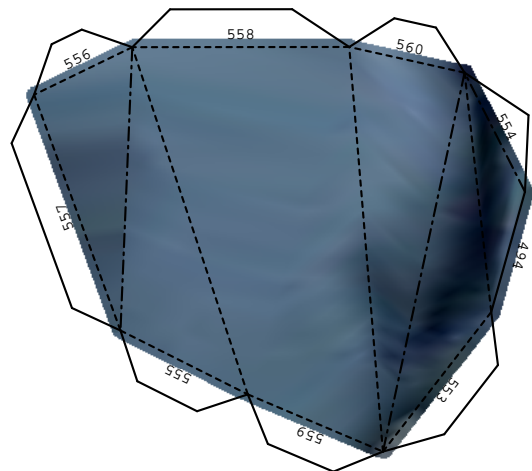
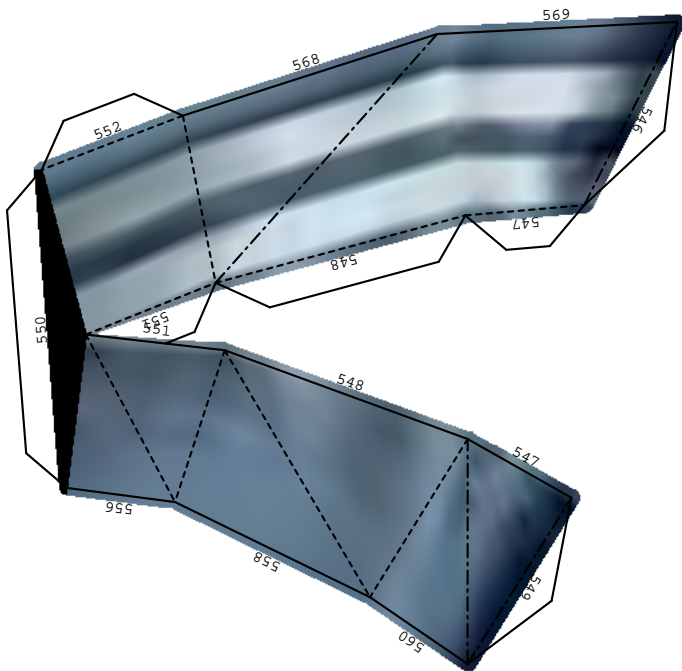
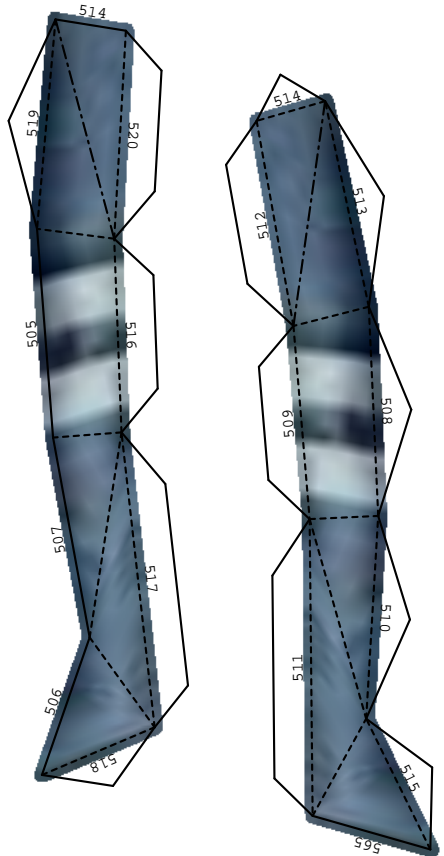
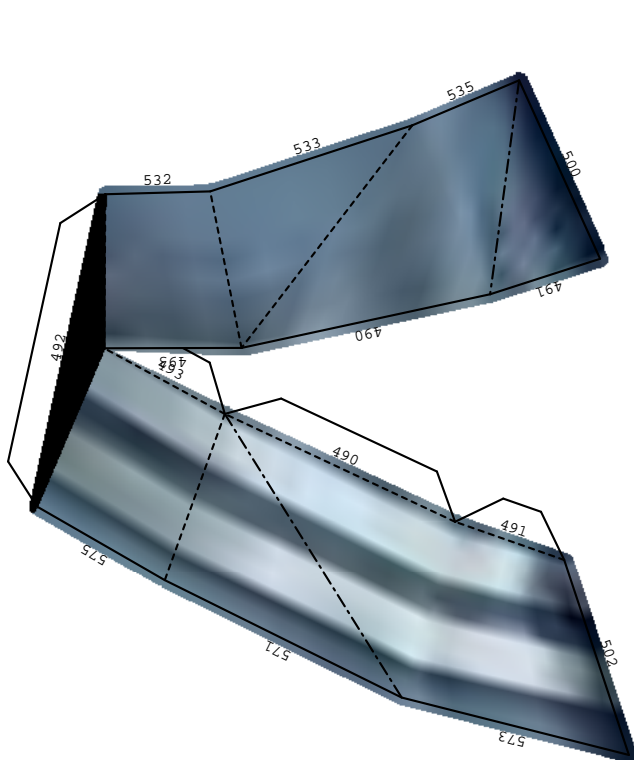





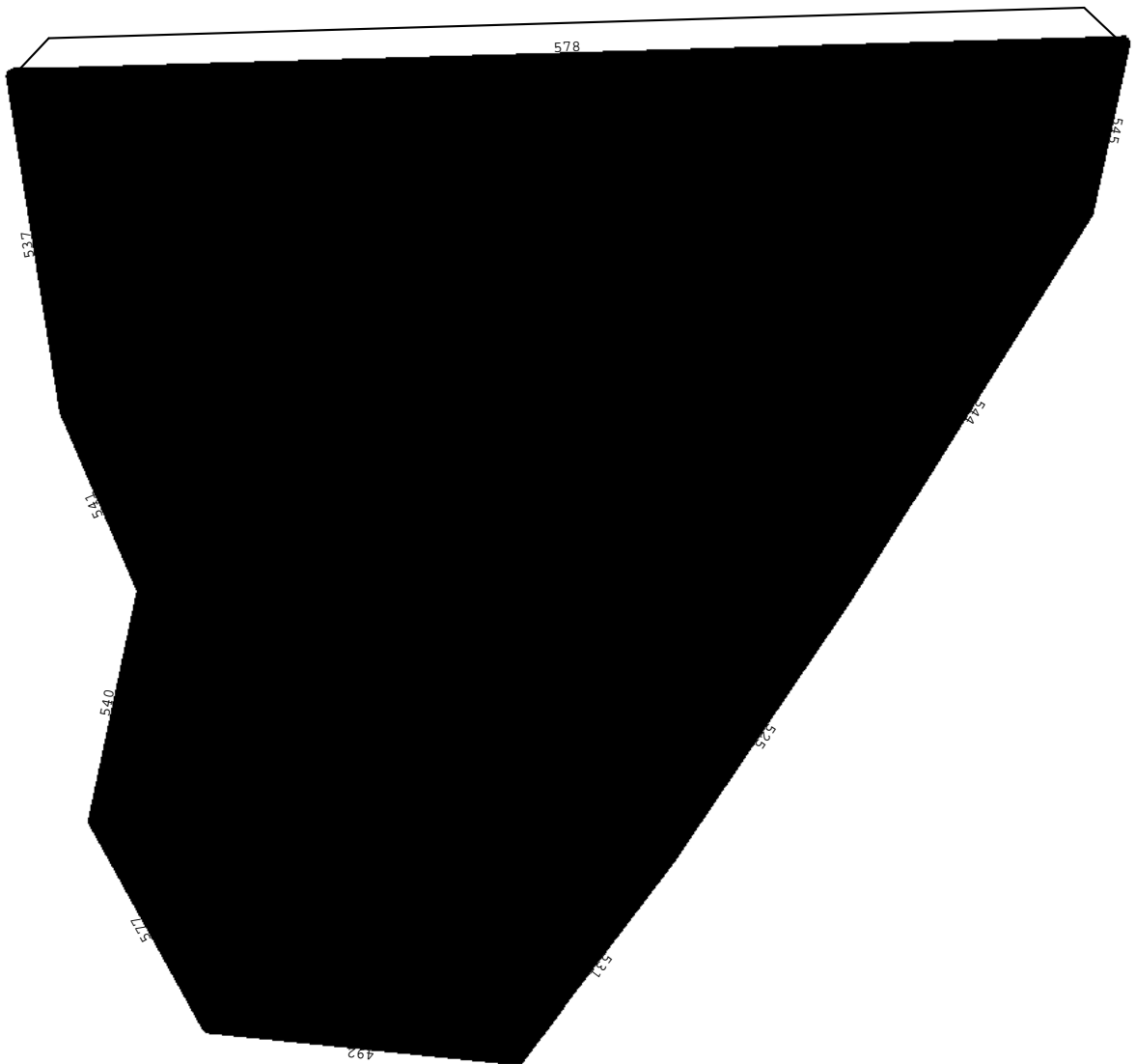
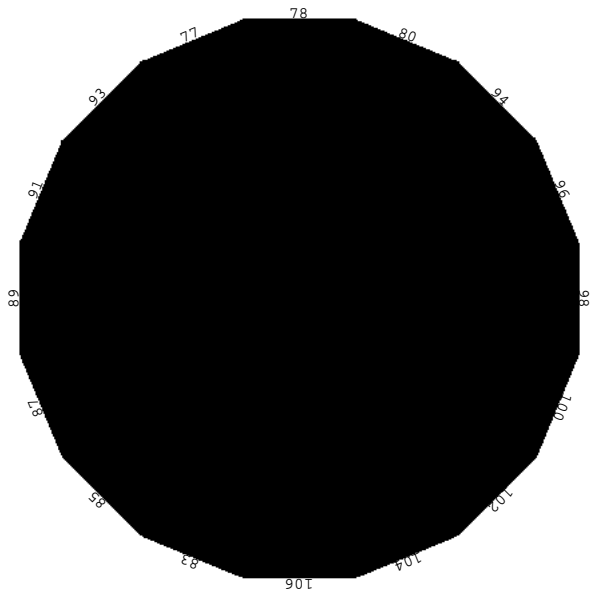

10/18 (row2 col4)

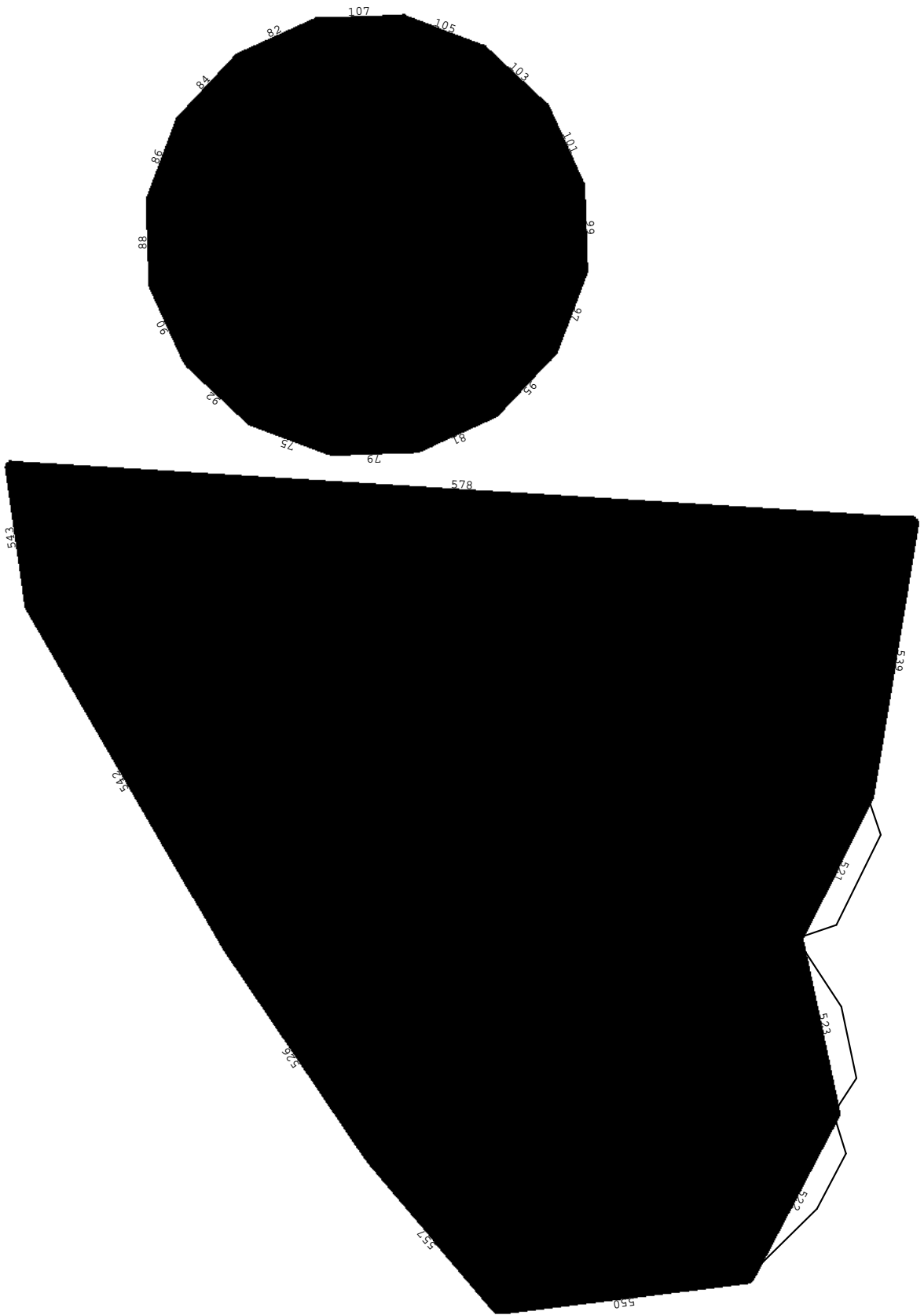

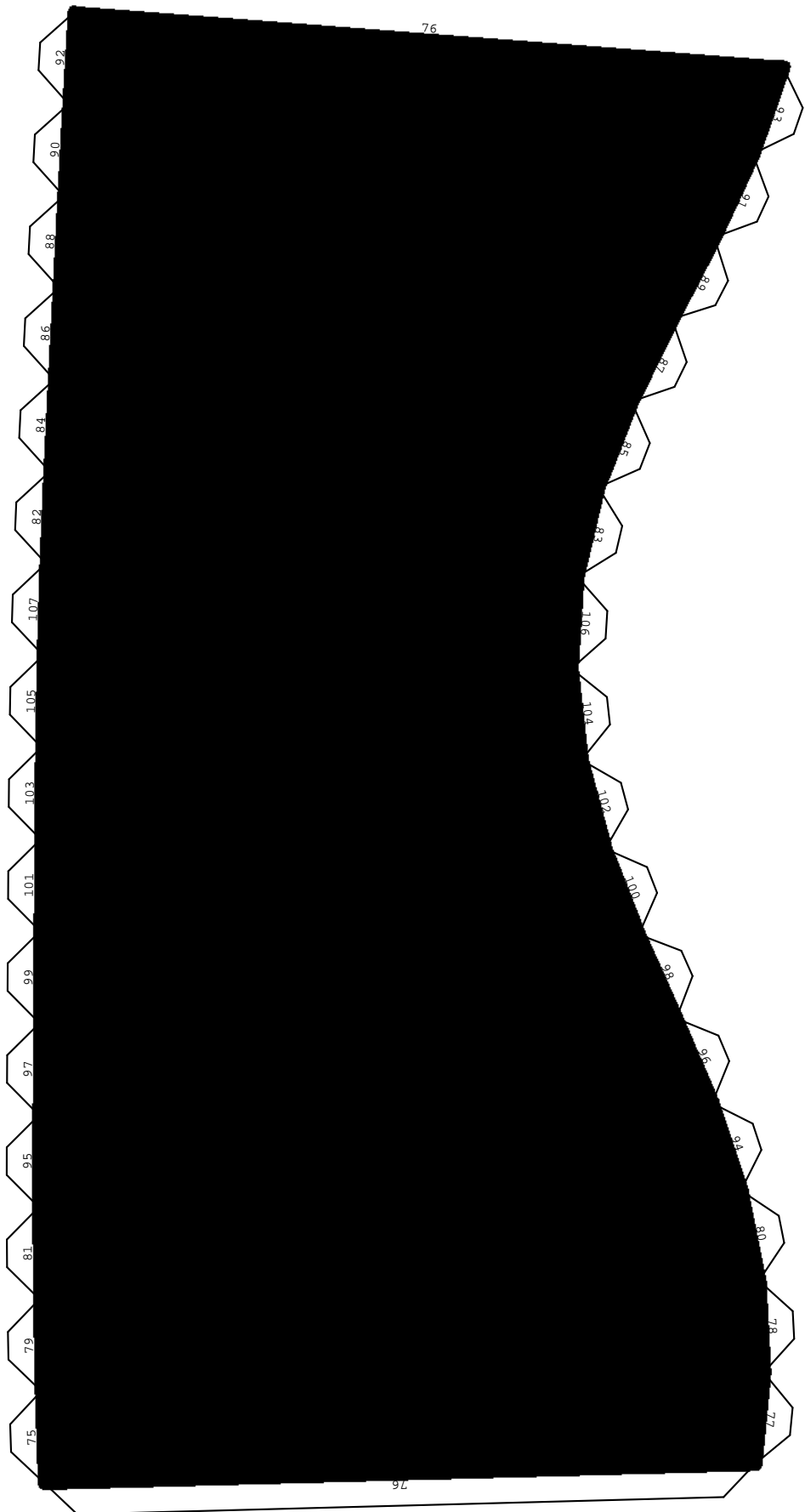

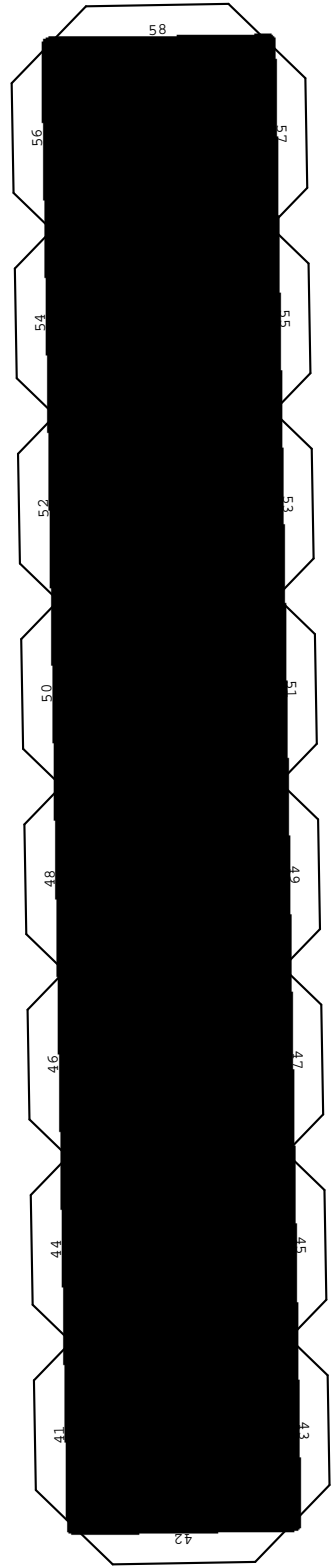
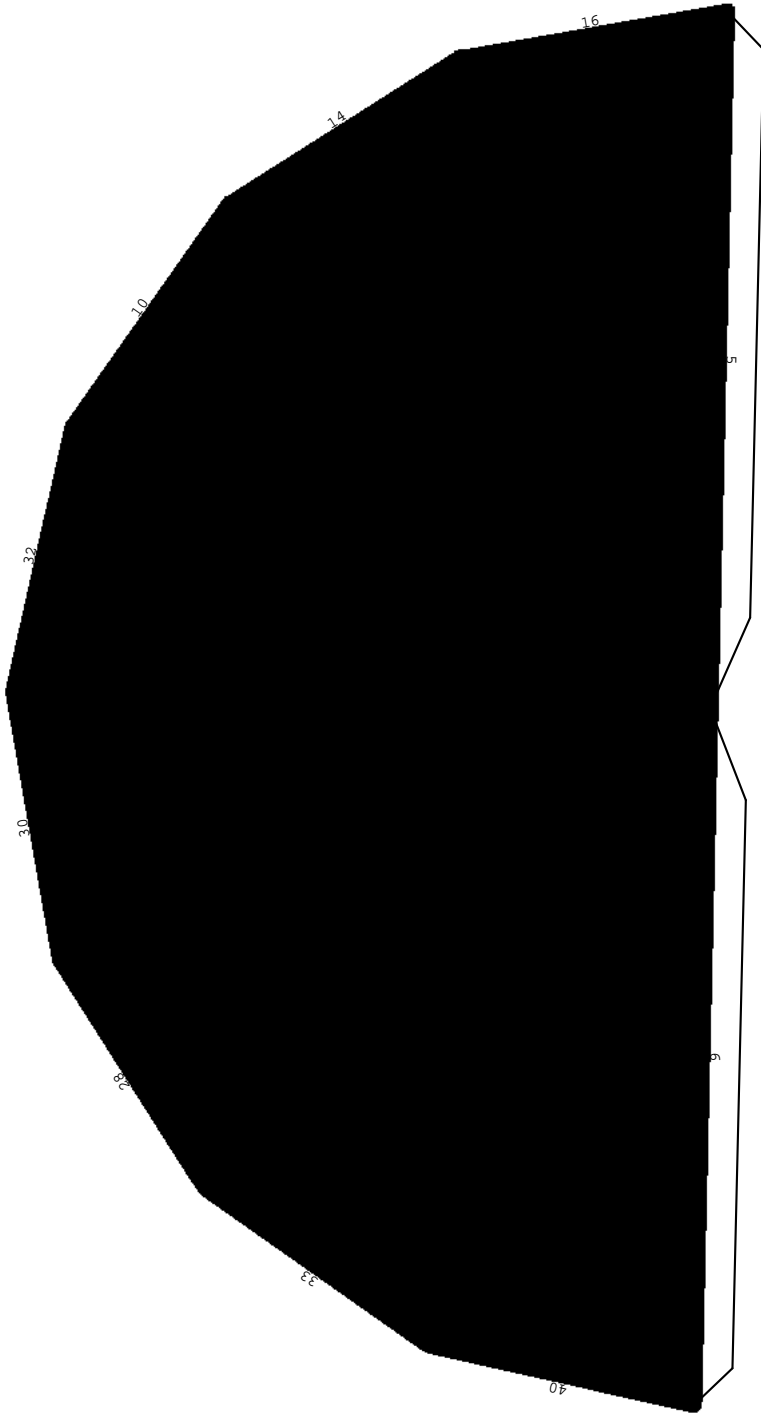



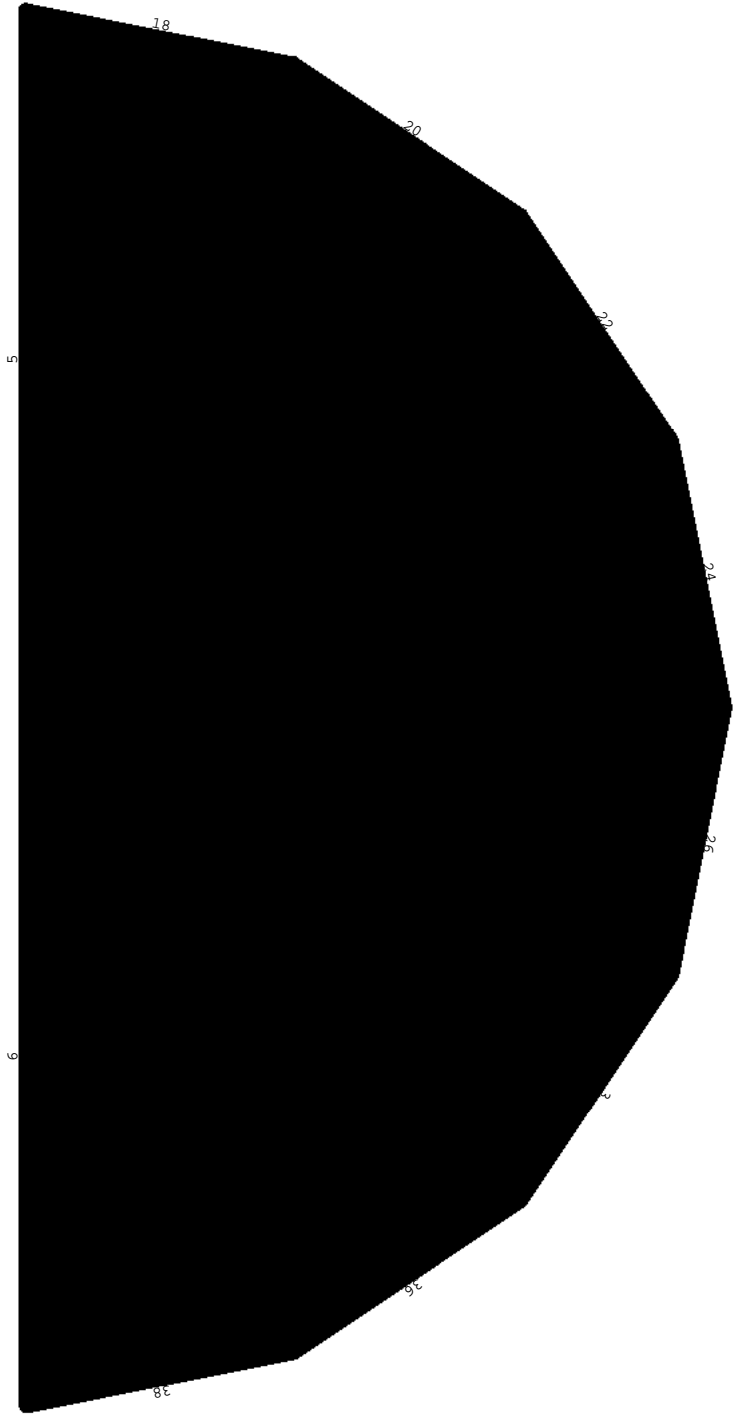
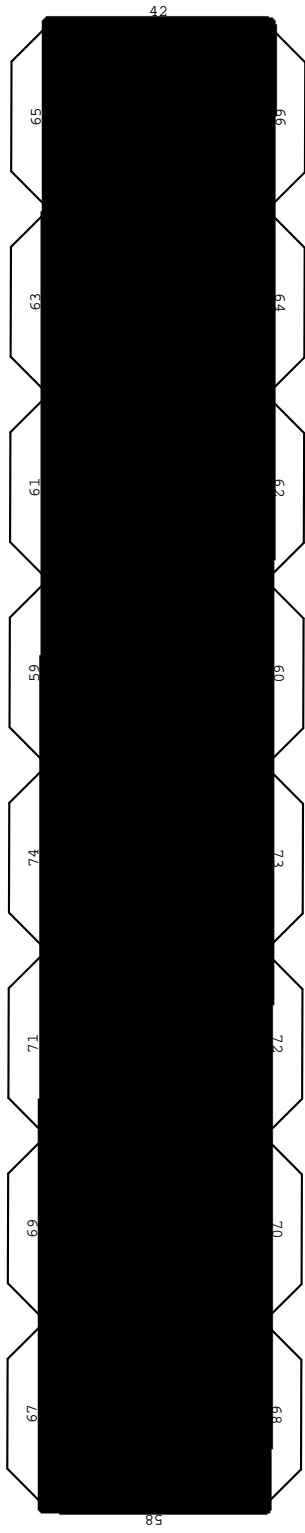

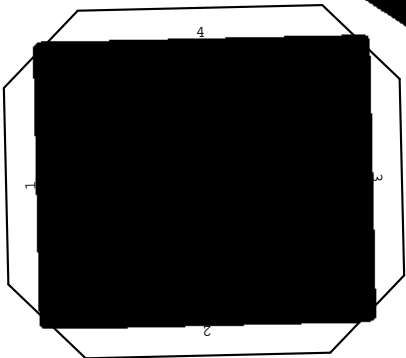



16/18 (row3 col4)

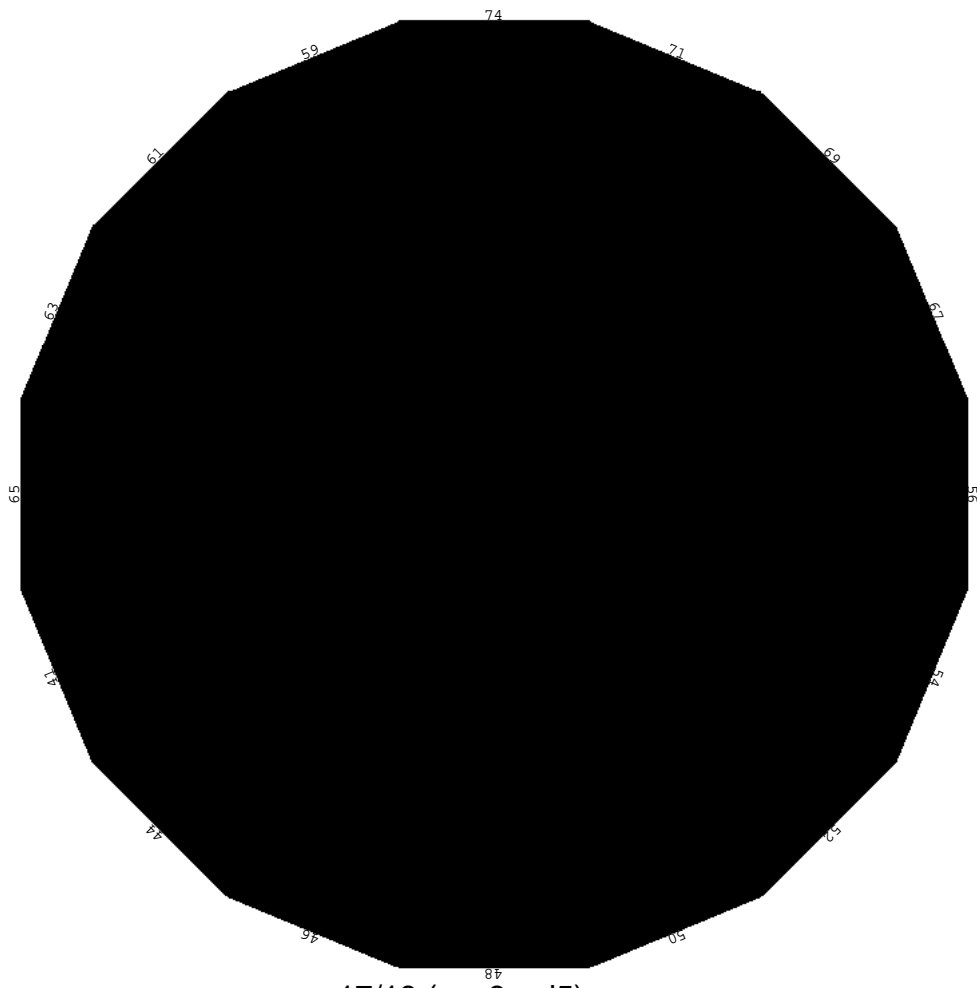
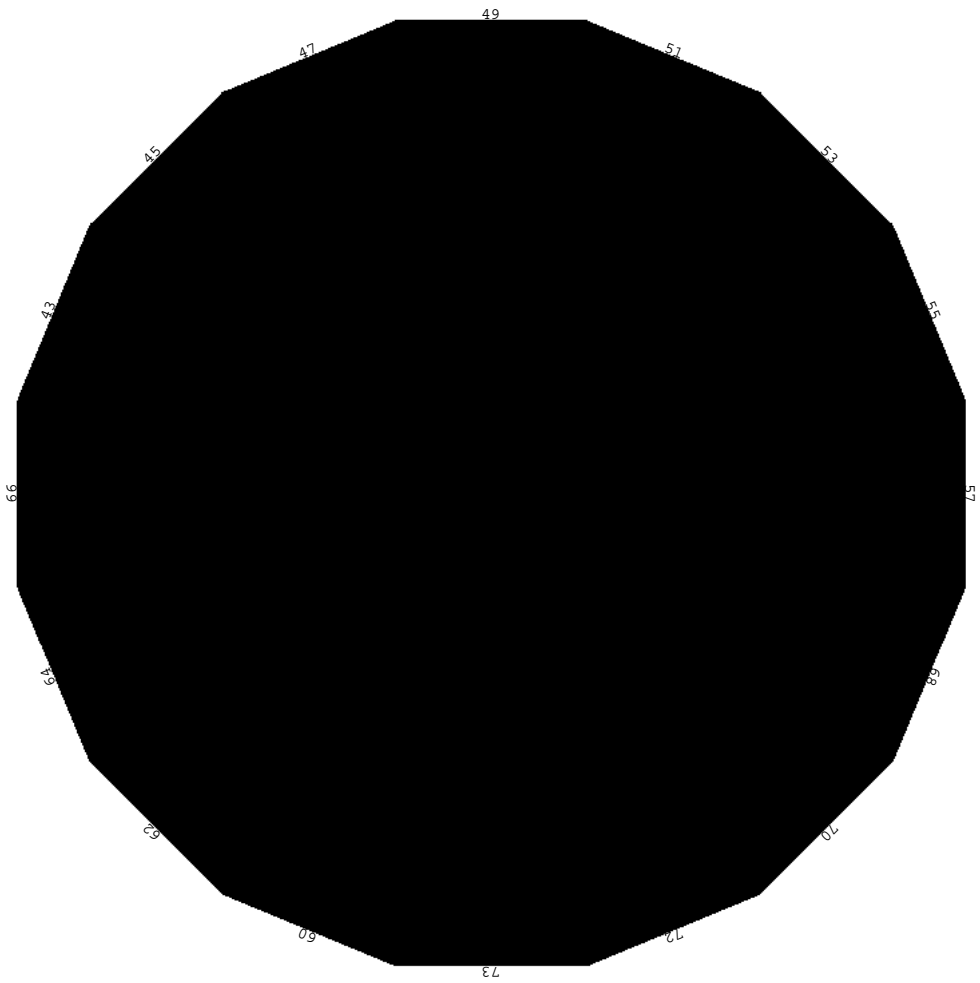

17/18 (row3 col5)

